



ACUCRAFT'S TOP FIREPLACE DESIGNS OF 2019

Acucraft's Top Fireplace Designs of 2019



We feel humbled to have been chosen by some of the world's greatest architects & designers who have trusted us to bring their fireplace designs to life.

Fireplace design trends have been changing over the past year to tall viewing areas and multi-sided fireplaces that can be viewed from multiple spaces. Our fireplace advisors and engineers are dedicated to creating the fireplace you've been dreaming of.

Every fireplace is built to order for a specific customer and we only use the highest quality materials & components. Backed by a Lifetime Guarantee, you can rest assured you're receiving the safest fireplace on the market.

We hope you enjoy our Top Fireplace Designs of 2019!

-The Acucraft Fireplaces Team

Acucraft's Custom Fireplace Spec Process



Step 1: INSPIRATION

Send Us Your Fireplace Inspiration

- Drawings
- Sketches
- Renderings
- Inspiration Photos

Step 2: COLLABORATION

Collaborate with our Fireplace Advisors & Engineers on your specific project details including:

- Design Intent
- Constraints / Challenges
- Finishing Options
- Desired Features

Step 3: SPECIFY

Easily specify your fireplace into your project using Acucraft provided specifications:

- Initial Design Specification Document
- Construction Guide Specification
- Inspiration Photos
- Initial Fireplace Design Sketch
- Custom Fireplace Quotation

**Request Your Custom
Fireplace Spec:
Acucraft.com/Fireplace-Specs
or Call US Today: (888) 317-6499**

INITIAL DESIGN SPECIFICATIONS

Project Name: _____ Date: _____
Company: _____ GC: _____ Quote #: _____
City: _____ Architect: _____ Email: _____
State: _____ Designer: _____
Fireplace Advisor: _____ Engineer: _____ (888) 317-6499

Media Type: _____
Burner Type: _____
Burner Dimensions: _____
BTUs: _____

Custom Gas Four-Sided Fireplace

Intake / Exhaust Size & Location
Class-A Chimney UL-103HT
Fan _____
Heat Relief Exhaust (B-Vent)
Fan _____
Heat Relief Intake (Location TBD)
Combustion Air Intake (Location TBD) (Insulated Single-Wall Duct)
Gas (Location TBD)
Electrical (Location TBD)

Additional Notes: _____

A: _____ D: _____ E: _____
B: _____ F: _____
C: _____

Zero Clearance
Viewing / Opening
H: _____ I: _____

Optional Corner Supports

Flue Options
 Single Flue
 Dual Flue
 Power Vent Exhaust Fan
 Glass Cooling Exhaust Fan
 Auto Mechanical Damper

Glass Options
 Single Plane
 Dual Plane
 Airshield
 Open (No Glass)
 Optional Corner Supports

Specifications are for reference only. Final specifications TBD during the design and submittal process.

www.acucraft.com | info@acucraft.com | Office: (763) 263-3156 | Fax: (763) 263-6311 | 19672.172nd Street, Big Lake, MN 55309



Custom Open Wood Fireplace

Private Residence | Eden, UT
Tom Wiscombe Architecture
Benchmark Modern Inc.
"The MEGA-Fireplace"

Custom Oval Gas Fireplace

JW Marriott | Nashville, TN
Stonehill Taylor Architects
Allegheny Construction Specialties
"The Mid-Century Free Standing Fireplace"

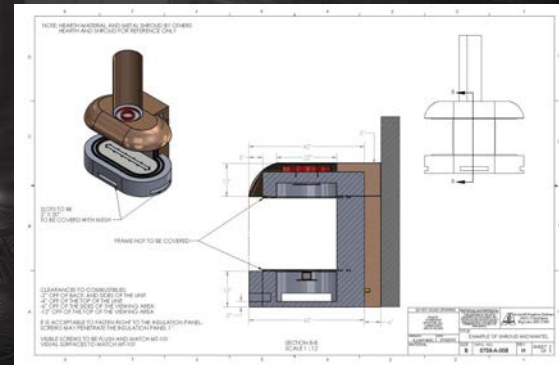

Custom See-Through Panoramic Gas Fireplace

Private Residence | Woodside, CA
 With + In LLC
 Conrado Home Builders
 "The Room Divider"

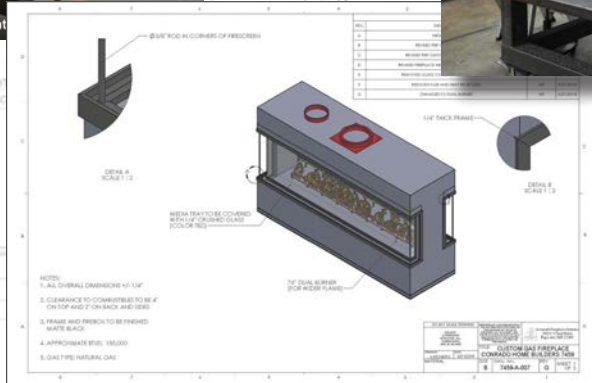
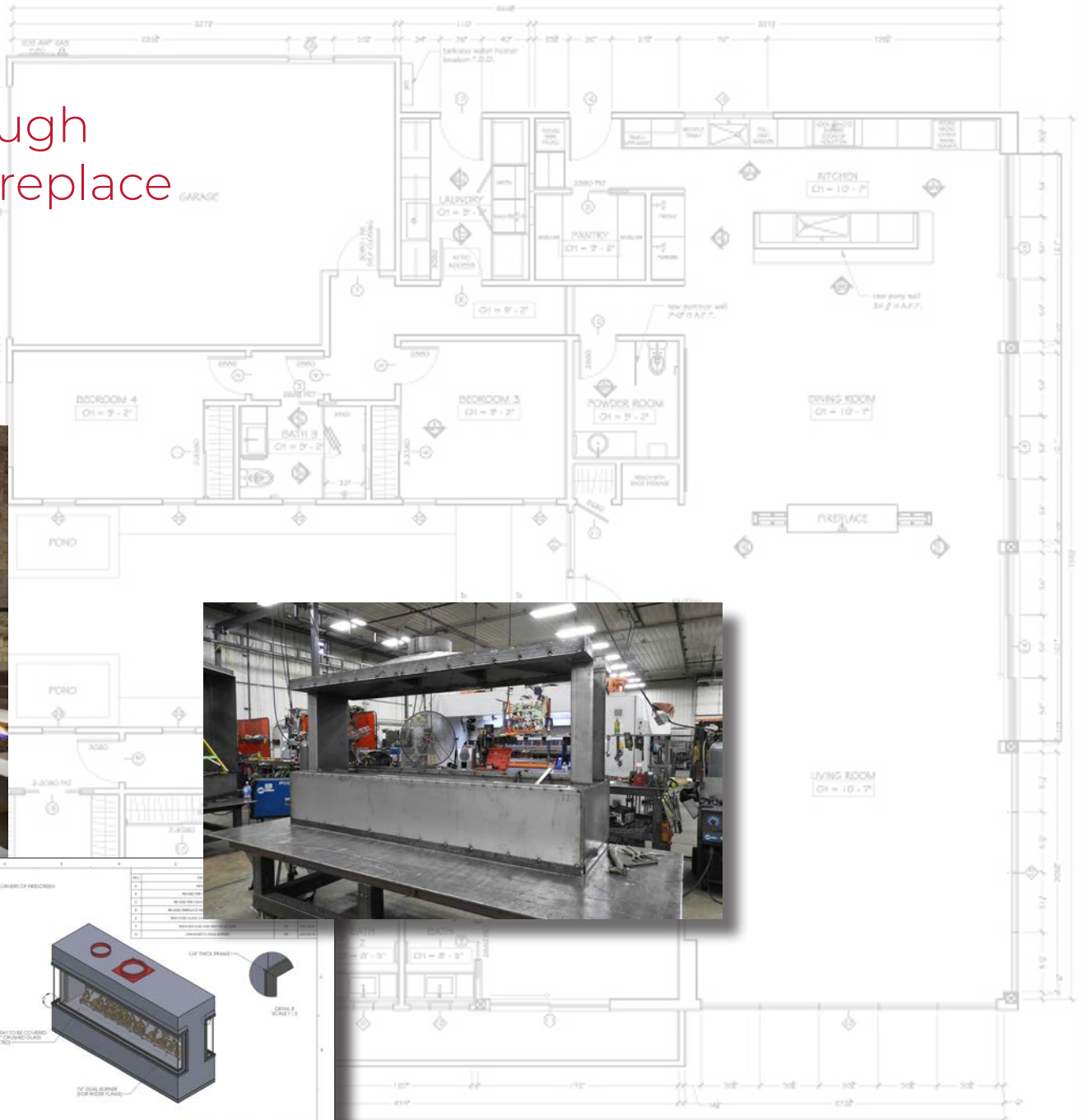

PROPOSED FLOOR PLAN
 SCALE = 1/4" = 1'-0"

SCALE = 1" = 10'-0" FEET

WITH + IN
 GABRIEL
 CATHRINE CO
 132 WALN
 MENLO
 CA 940

APPROVED / REVISED

SCALE 1/4" = 1'-0"

PROP
 FLOOR

CAA

Custom Linear Gas Fireplace

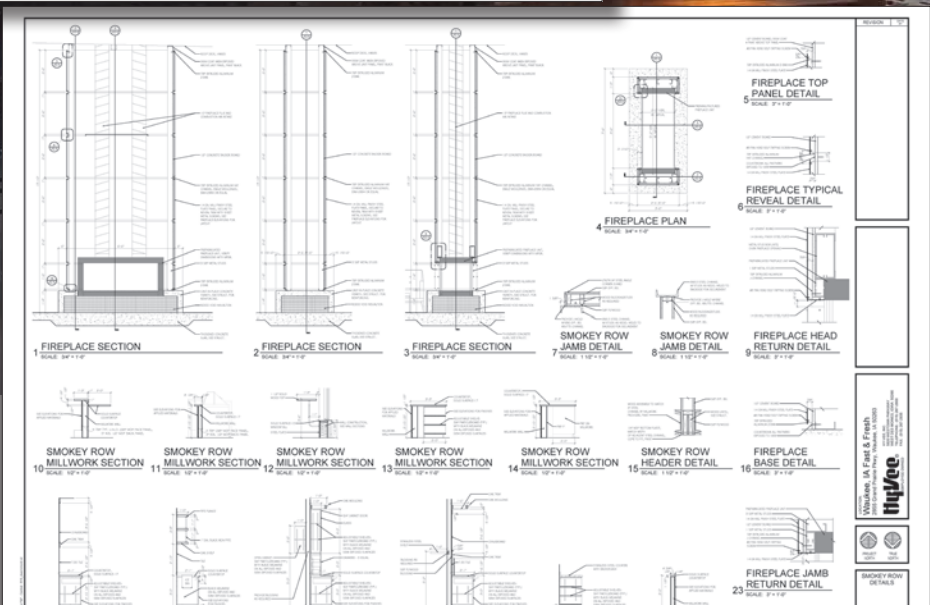
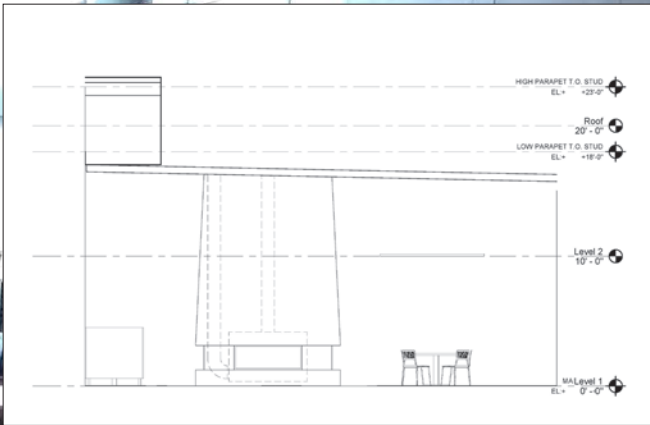
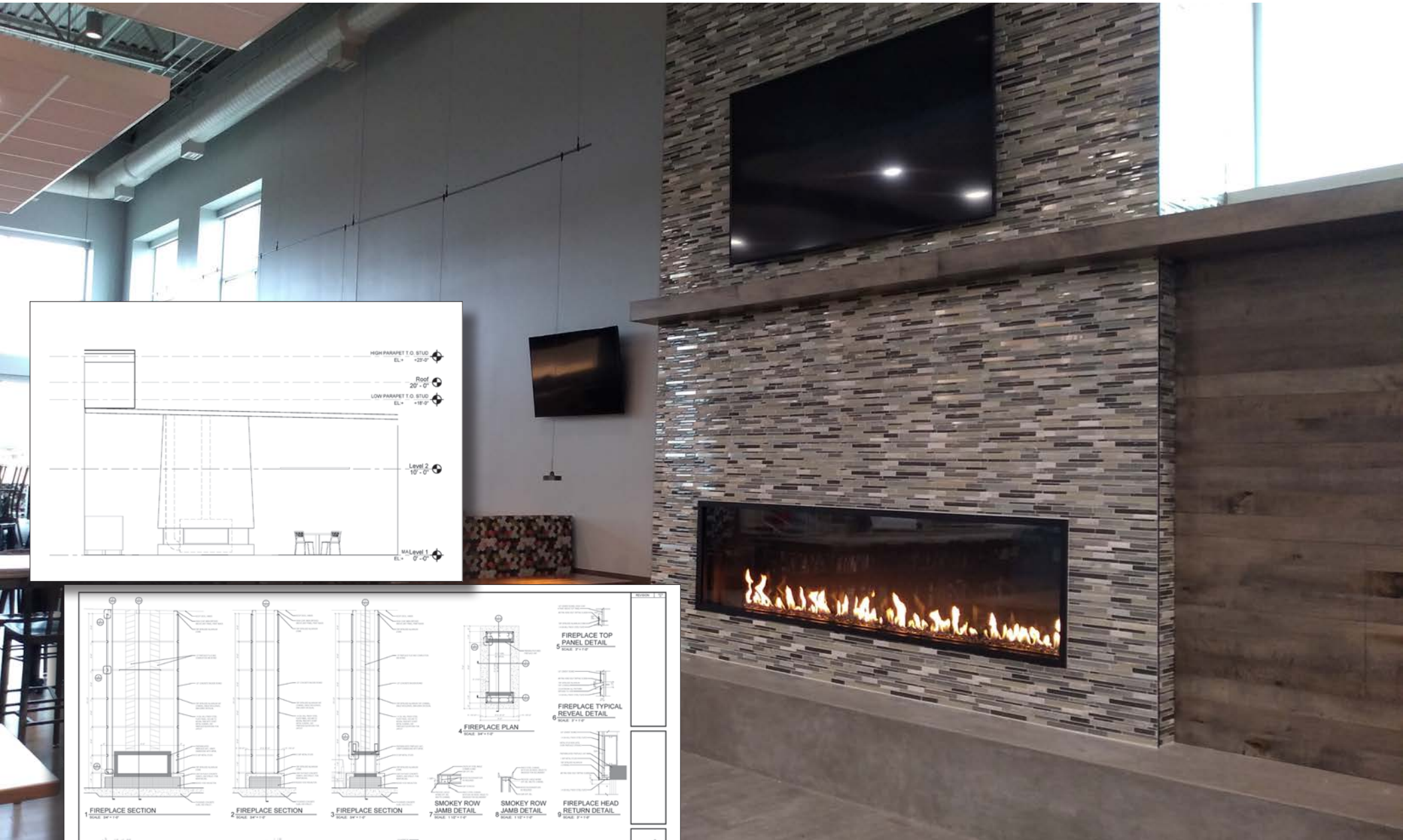

Custom Indoor/Outdoor Gas Fireplace

Taco Bell | Pacifica, CA
C.M. Architecture, P.A.
Golden Gate Bell, LLC
"The Taco Bell Fireplace"

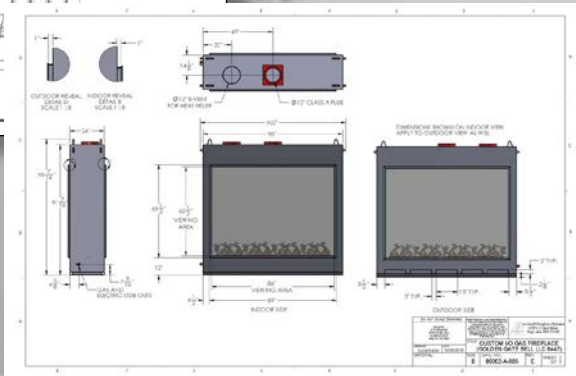
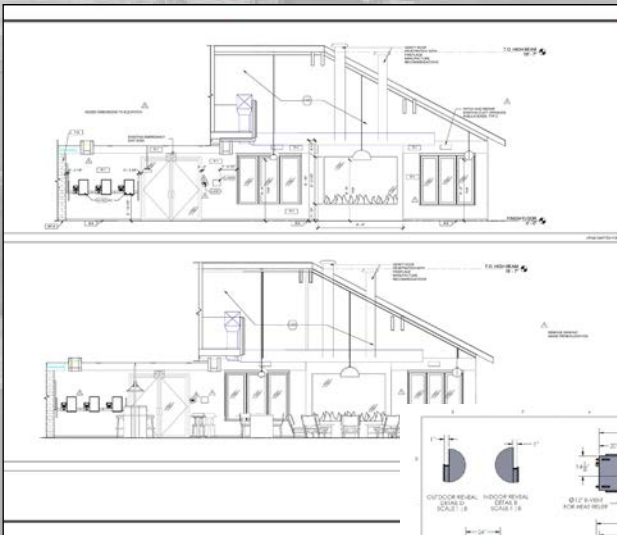
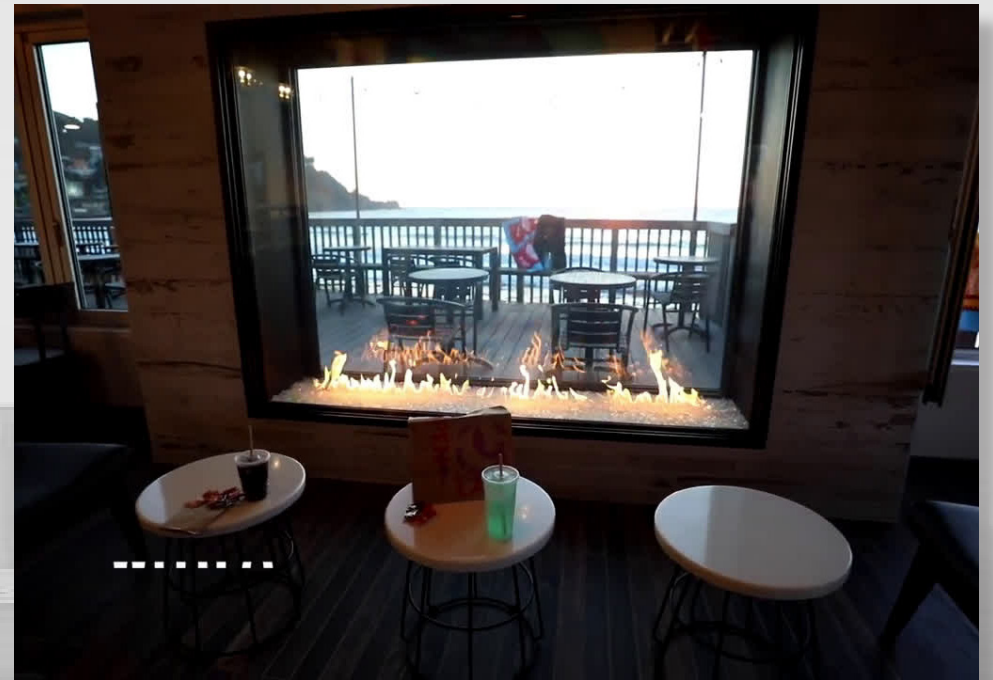

Custom 3-Sided Modular Gas Fireplace

Private Residence | Truckee, CA

Ike Kligerman Barkley

Jones Corda Construction

"The Martis Camp Fireplace"

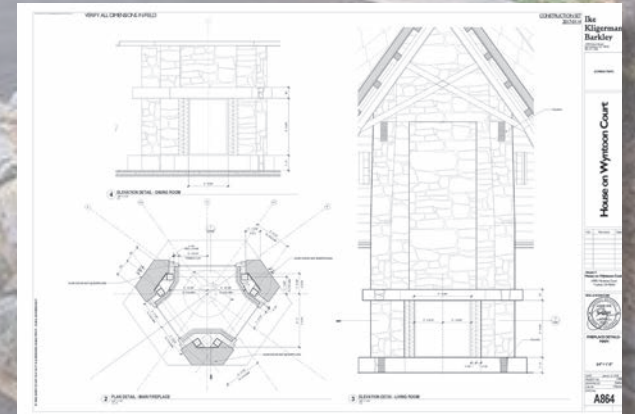
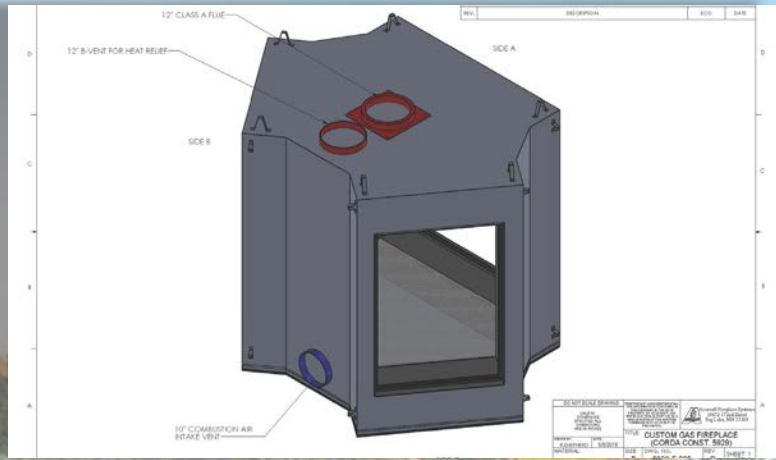

Custom 3-Sided Gas Fireplace

Colorado Community Church | Aurora, CO
 Lee Architects / Interior Designers
 Fransen Pittman General Contractors
 "The Congregation's Fireplace"



LEE ARCHITECTS/
 INTERIOR DESIGNERS
 2400 S. WASHINGTON BLVD., SUITE 401
 AURORA, COLORADO 80012
 PHONE: 303.733.1111
 FAX: 303.733.1112

COLORADO COMMUNITY
 CHURCH
 14000 EAST JEWELL AVE.
 AURORA, COLORADO 80012

Job No: 17022

Date: CD SET
 12-6-2018

Drawn by: LTD
 Checked by: EKH

Title: FIREPLACE DETAILS

A702

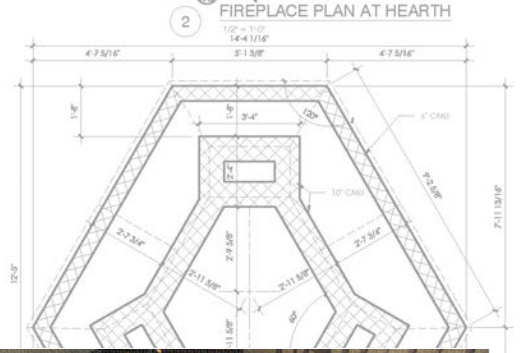
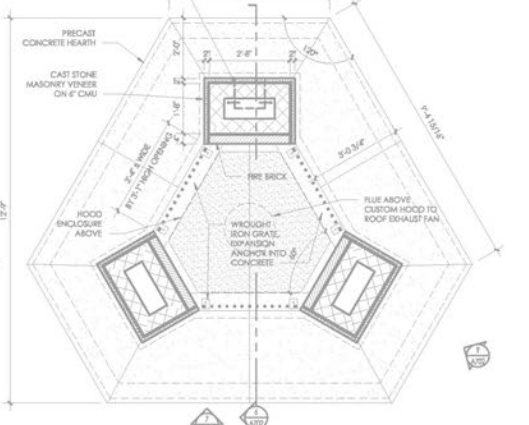
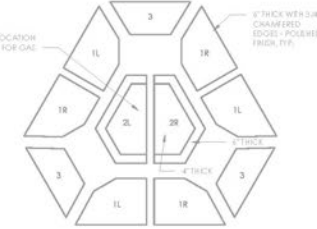
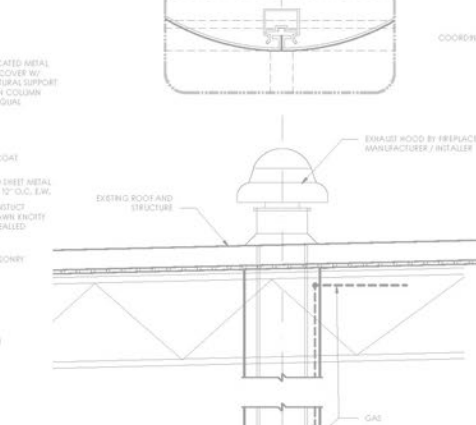
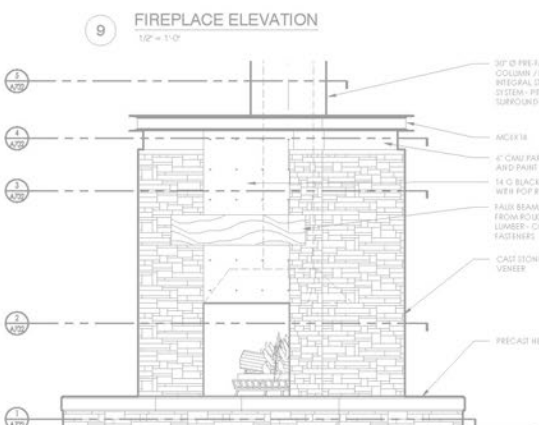
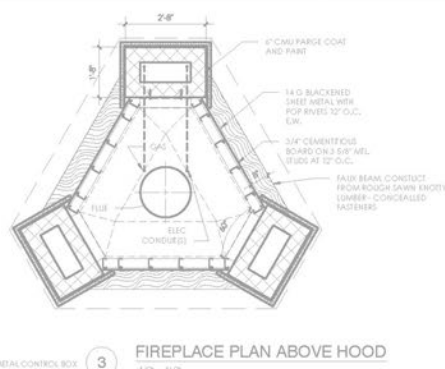
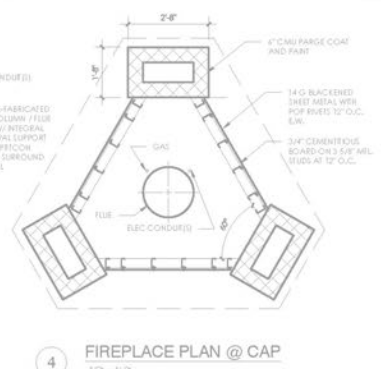
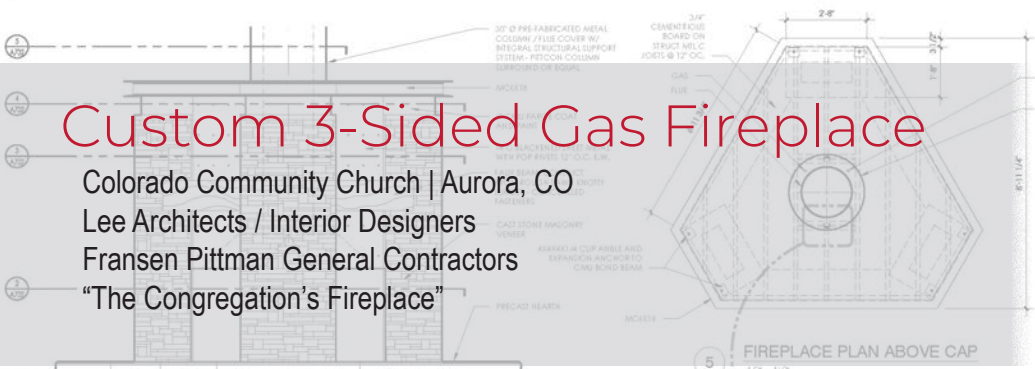

Custom See Through Open Gas Fireplace with Logs

Private Residence | Grand Rapids, MI
 J Visser Design
 Douglas Sumner Builder, Inc.
 "The 4-Sided Open Reveal"

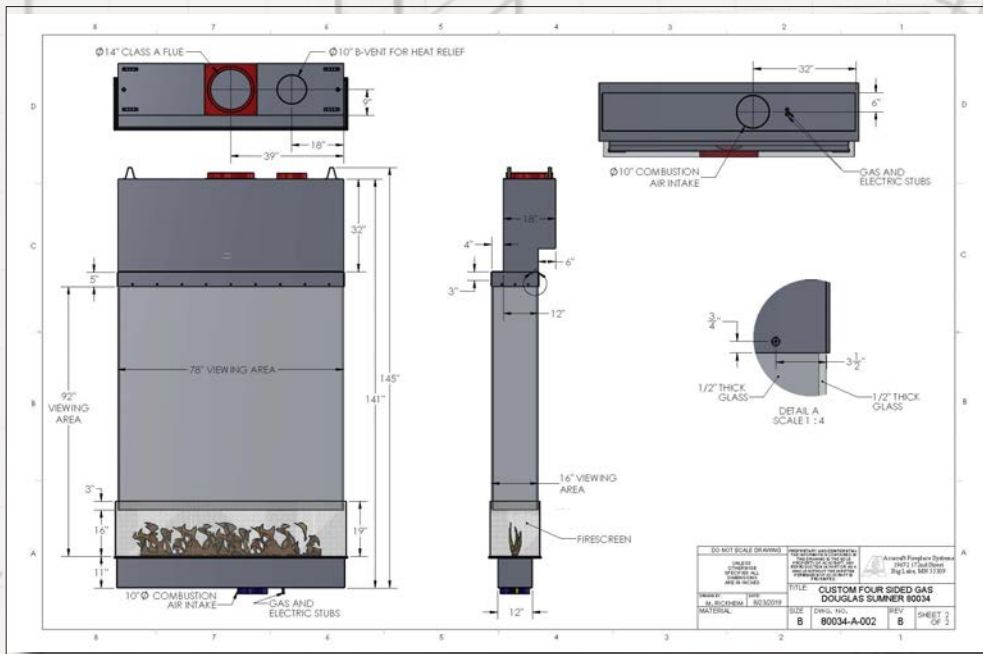
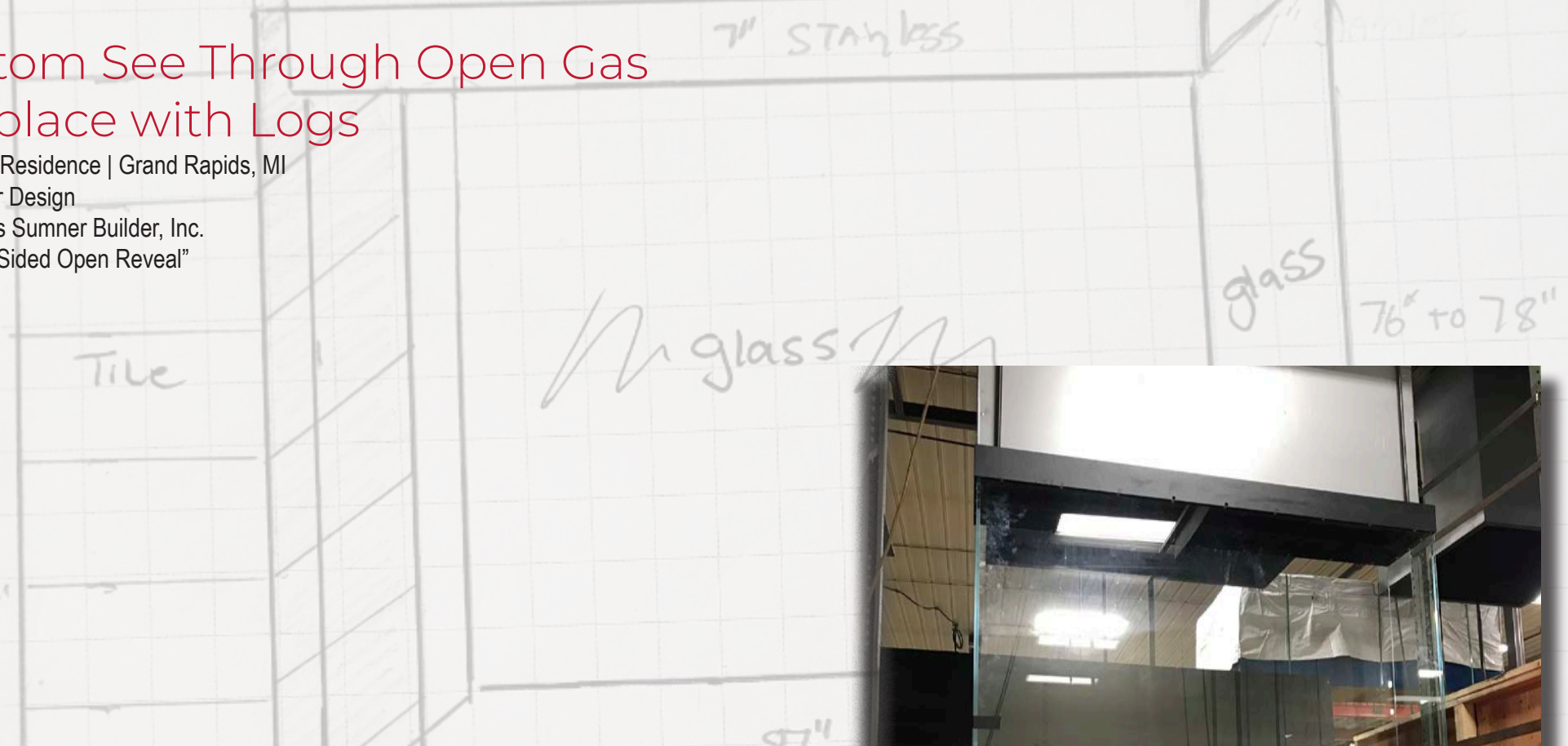

Amazon Block 18 Custom Multi-View Fireplace

Amazon Block 18 | Seattle, WA
 Graphite Design Group
 Sellen Construction
 "The L2 Fireplace"

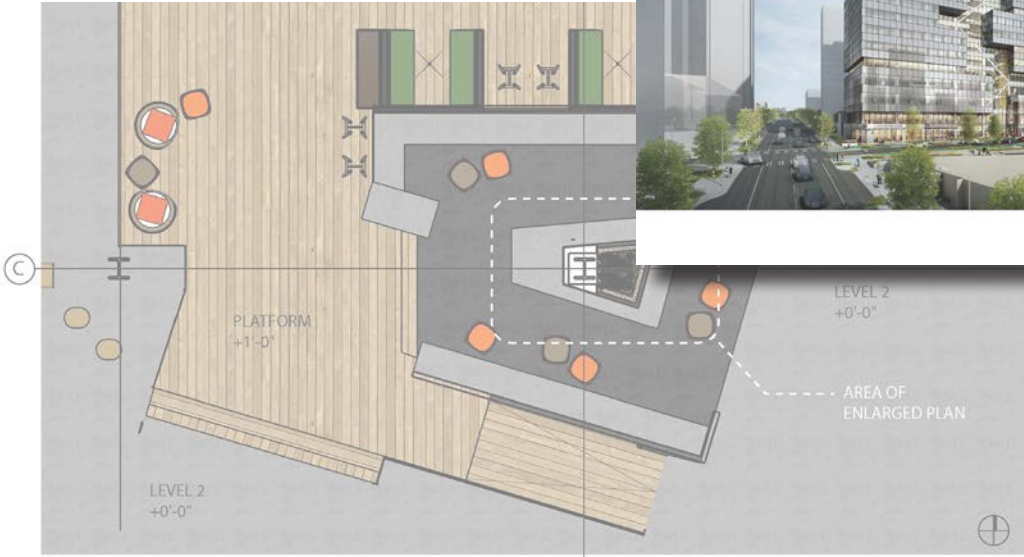
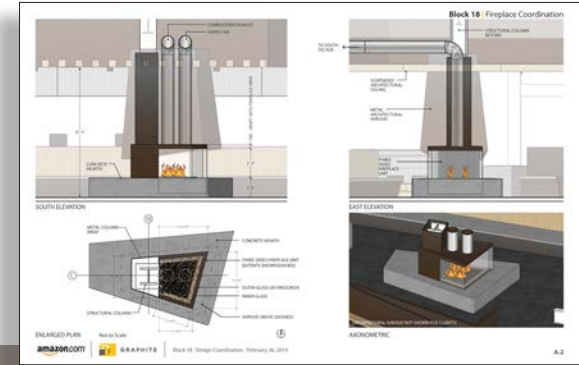

PARTIAL LEVEL 2 PLAN



VIEW FROM PLATFORM - LOOKING NORTHEAST



VIEW FROM PLATFORM - LOOKING SOUTHEAST

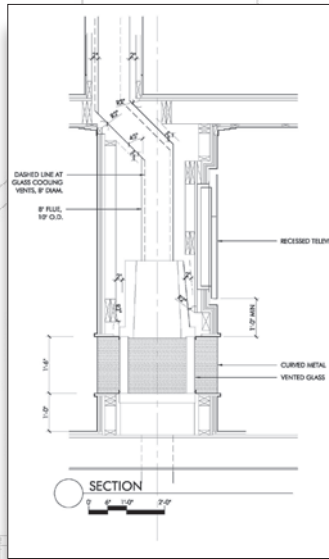

77" TV

SLAB

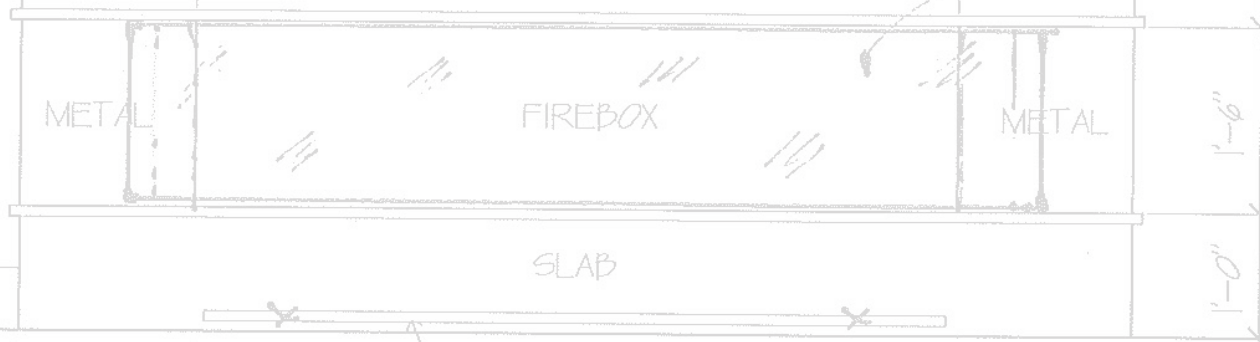
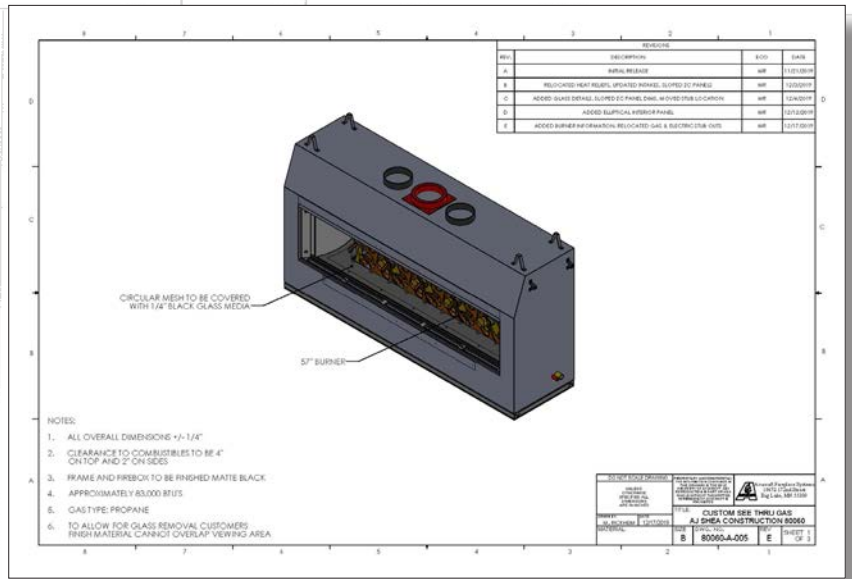

FRONT

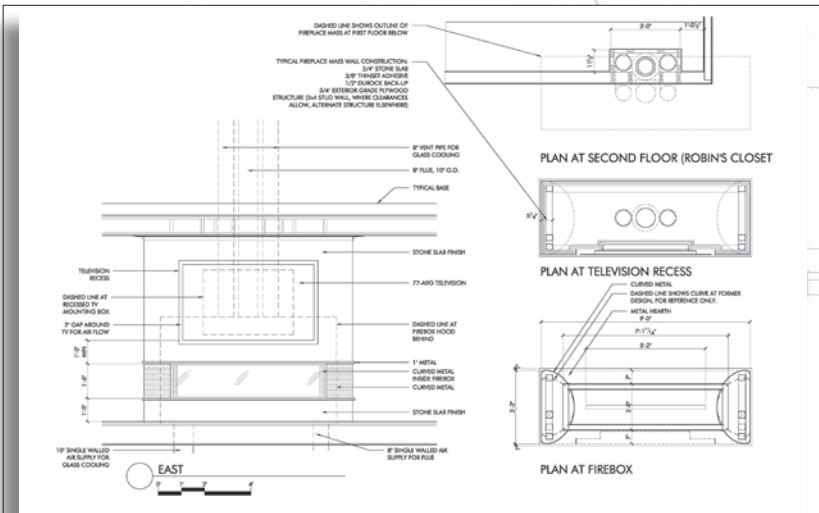

NEED ACCESS
PANEL LOCATION.
(12" x 12")

Custom Angled Linear See-Through Gas Fireplace

Private Residence | Old Saybrook, CT
Tate & Burns Architects LLC
A.J. Shea Construction
"The Seamless Fireplace"



The Fireplace Industry Problem We Solve

Other fireplace manufacturers do not guide their customers or provide one-of-a-kind solutions. At Acucraft we know what it's like to want something unique.

Don't settle for boring, mass-produced fireplaces; instead, choose the fireplace you've been dreaming of. By working directly with the manufacturer you're able to get exactly what you want.

The *Acucraft Process* was developed for customers like you. Our goal is to bring your fireplace dreams to life while giving you a world-class experience. Start Your Journey Today!



Discover



Deliver



Adore